

V1. 1

--
--
--

KE-GT(15-25)KTL4

V1.0	2023-2-16	
V1.1	2023-12-06	12kW

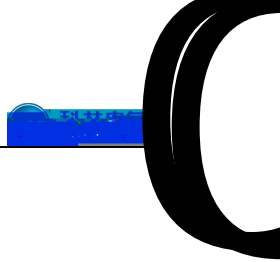











5



2

0.5

	-		
			
			6
			
			5



1	6
1.1	6
1.2	6
1.3	7
1.4	8
2	10
2.1	10
2.2	10
2.3	11
2.4	13
2.5	14
3	16
3.1	16
3.2	16
3.3	19
3.4 RS485	21
3.5	21
4	24
4.1	24
4.2	24
5	25
5.1	25
5.2	27
6	29
7	31
8	32

1

1.1

T

1

98.6%

1.5

20A

1100V

45

2

APP

3

IP66

4

5

1.2

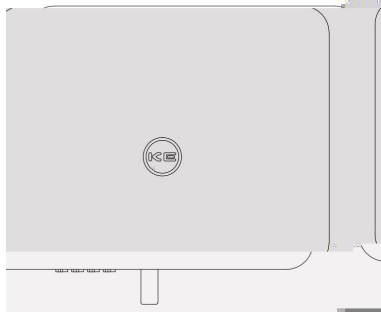

1.3

KE-GT25KTL4

光伏并网逆变器

产品型号: KE-GT25KTL4

DC 输入	
最大输入电压:	1100V
MPPT电压范围:	200~1000V
最大输入电流:	32A+2
MPPT路数:	2
每路MPPT最大连接组数:	2
AC 输出	
额定输出功率:	25kW
最大输出电流:	3*40A
额定输出电压:	3/N/PE-100V
输出频率:	50Hz
相序:	+30 C-+60 C0
绝缘等级:	IP20
全等级:	I
制造商:	石家庄科林电气股份有限公司

规格: 25kW
 尺寸: 300*400*100mm
 重量: 10kg
 电话: 0311-83231087
 网址: www.kelin.com.cn

1. 4

	KE- GT15KTL4	KE- GT17KTL4	KE- GT20KTL4	KE- GT23KTL4	KE- GT25KTL4
	22.5kW	25.5kW	30kW 1100V 180V 580V	34.5kW	37.5kW
MPPT			200V 1000V		
MPPT	2	2	2	2	2
MPPT	2/				

1/1

WM K

40W



	520mm*410mm*220mm				
	20kg	21kg	21kg	21kg	21kg
	IP66				
	1W				
	-30 60				
	0 100%				
	69dB				
	4000m		2000m		
	LED				
	RS485				
	4G/WIFI				
	CNCA/CTS0002-2014 NB/T 32004-20-				

2

2.1





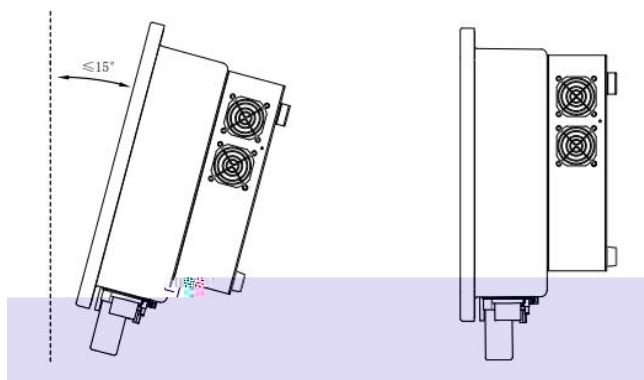

2.2

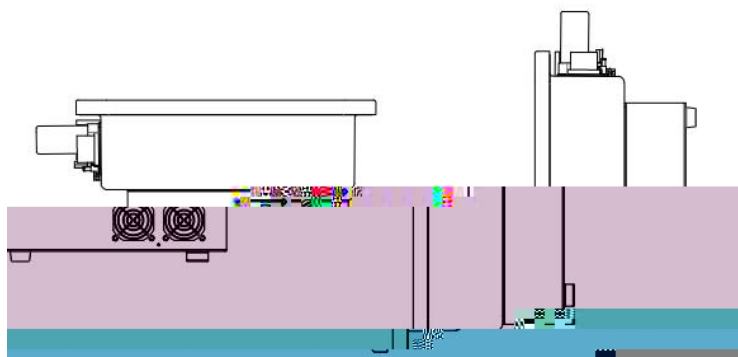

2.3

IP66



2.4

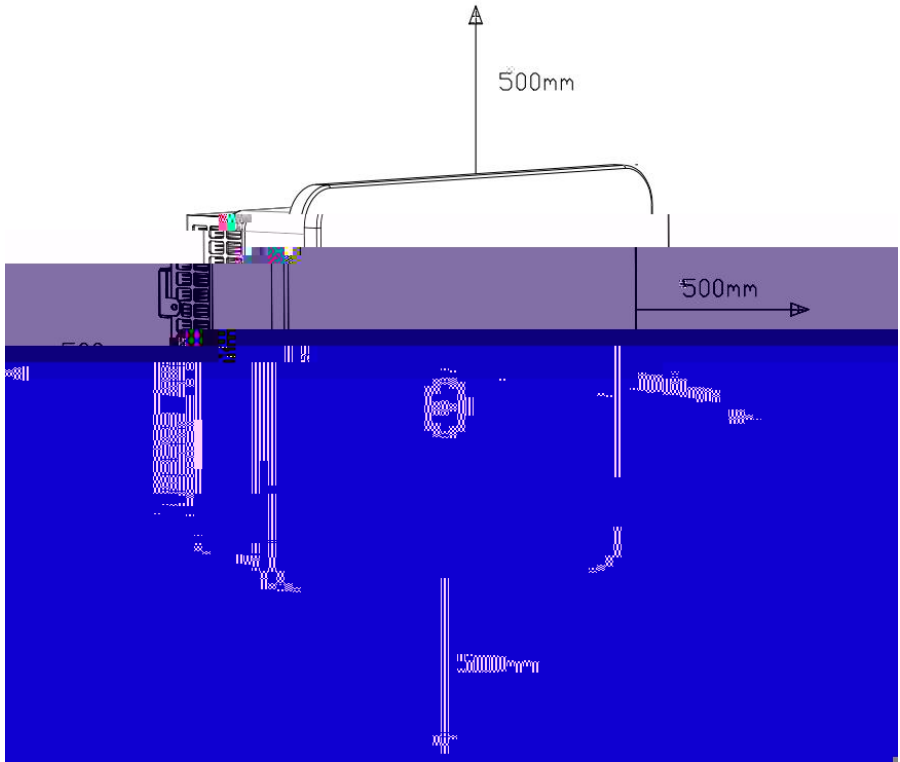

2.4

75

-30-60

500mm

500mm

2.5

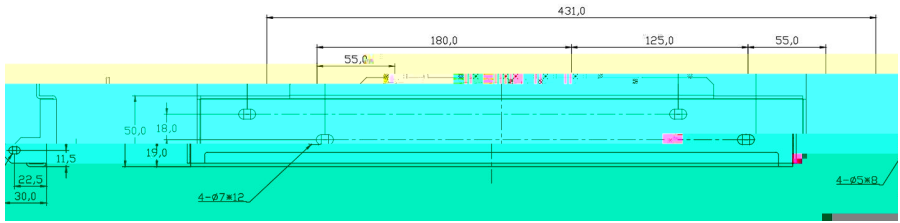

2.5

1



4.

2.7

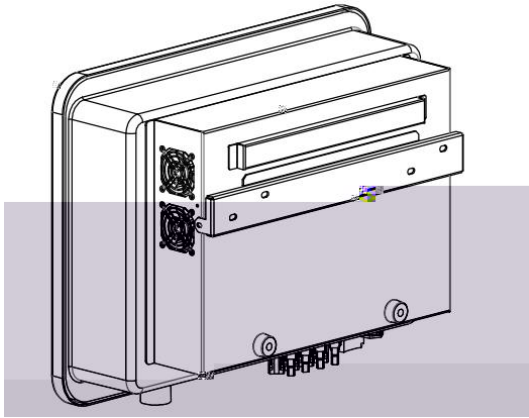

2.7

5.

(2.8)

紧固螺丝

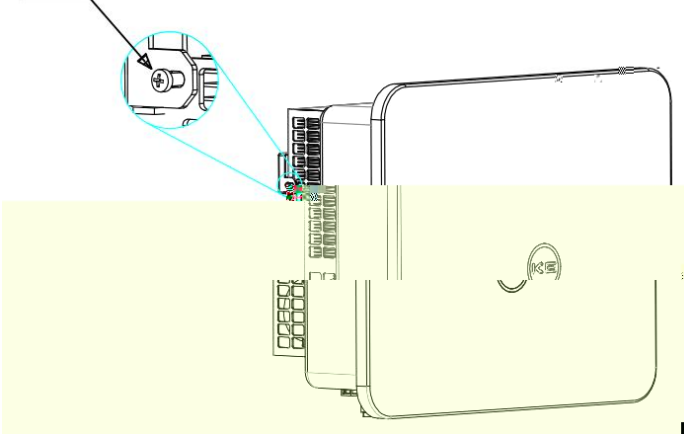

2.8

3

3.1

KE-GT 15-25 KTL4

3.1

+	
-	
DC1	1
DC2	2
USB	
RS485	

3.1

- 1.
- 2.
- 3.
- 4.

3.2

3.1 3.2

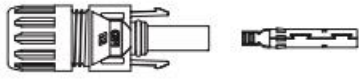

3.1 (PV+)



3.2 (PV-)

1. 7mm

3.3



3.3

2.

3.4

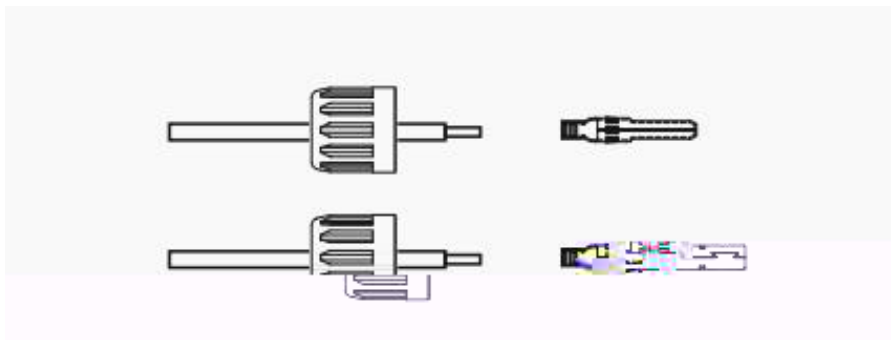

3.4

3.

3.5

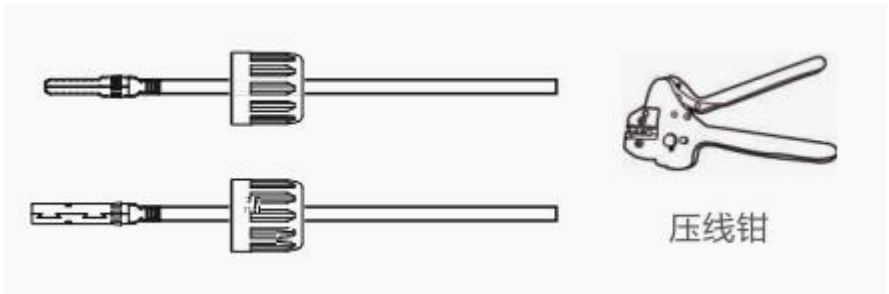

3.5

4.

3-4Nm

3.6

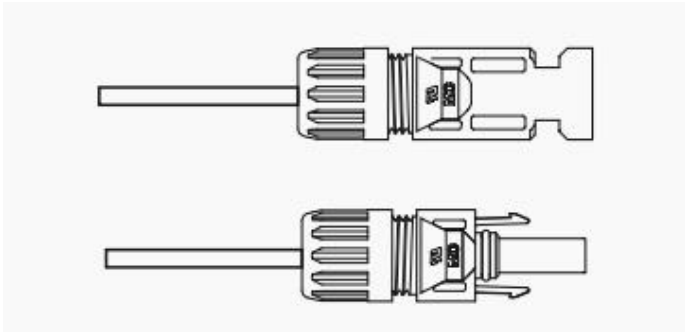

3.6

5.

PV

(3.7)

3.8



3.7

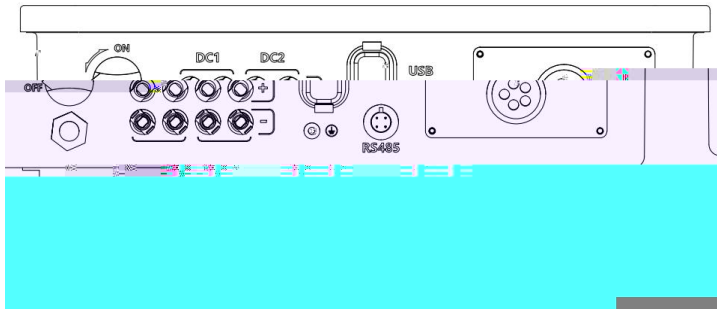

3.8

	mm $\bar{\phi}$		mm
PV1-F	4.0-6.0 (12-10AWG)	4.0 (12AWG)	5.5-9.0

3.3

KE-GT 15-25 KTL4

6-16mm $\bar{\phi}$, YJV-0.6/1KV

1.5ohm

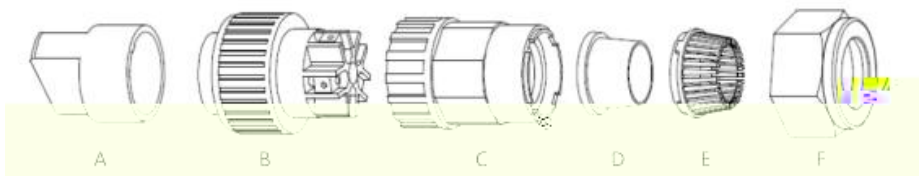

配件	序号	说明
交流连接器	A	塑料夹盖(辅助安装)
	B	接线端子
	C	线套主体
	D	较厚的密封塞适用于外径12-18mm的线缆 较薄的密封塞适用于外径16-21mm的线缆
	F	垫圈
	F	螺母

3.9

" L1" " L2" " L3" " N" " PE"
 L " L1" " L2" " L3" " PE" " N"

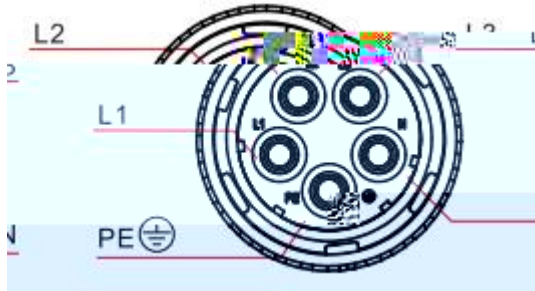

3.10

1.

70mm 10mm

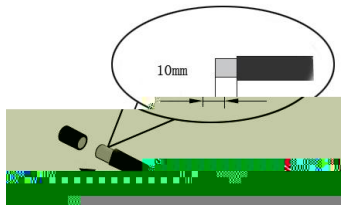

3.11

2.

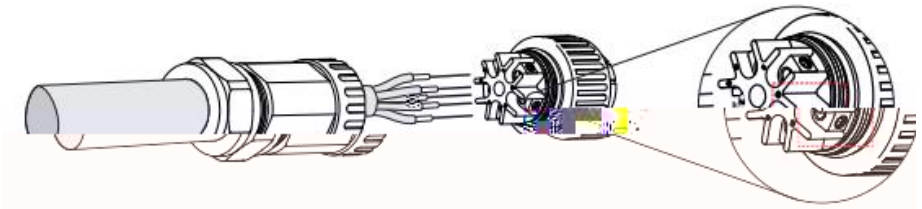

3.12

3.

3-4N m

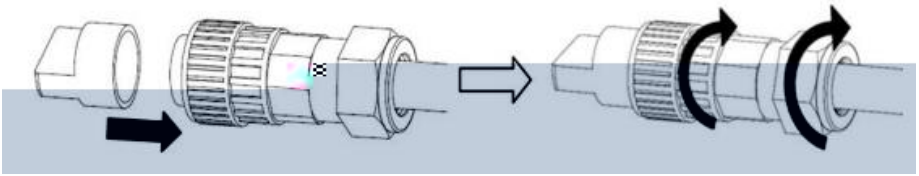

3.13

4.

3.4 RS485

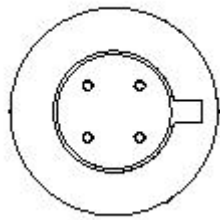

PI N

RS485_1

1. : 6mm²

2. OT M6

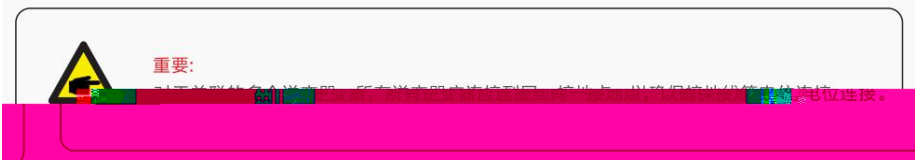

3. 3.14)

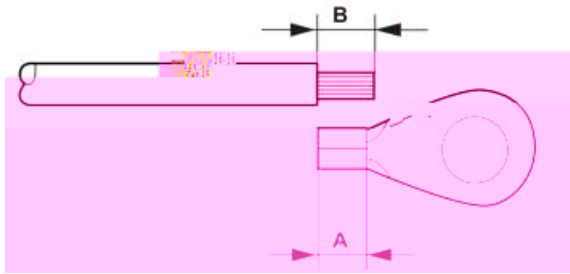

3.14

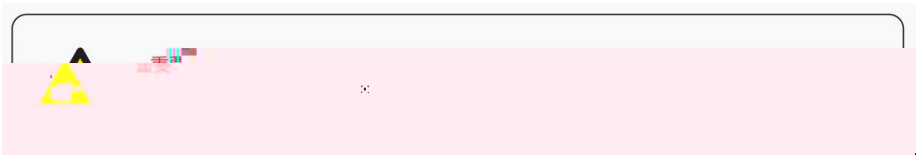

4. OT

3.15

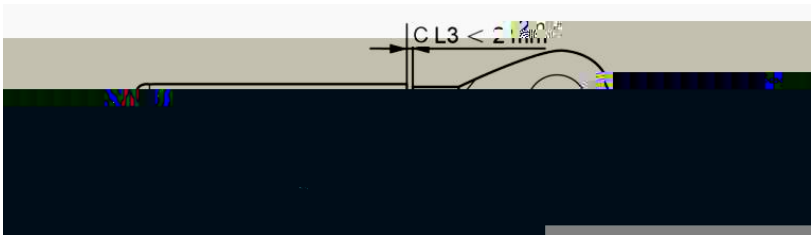

3.15



重要:

将端子压接到线缆后，检查连接以确保端子牢固地压接到线缆上。

5.

6.

3.16

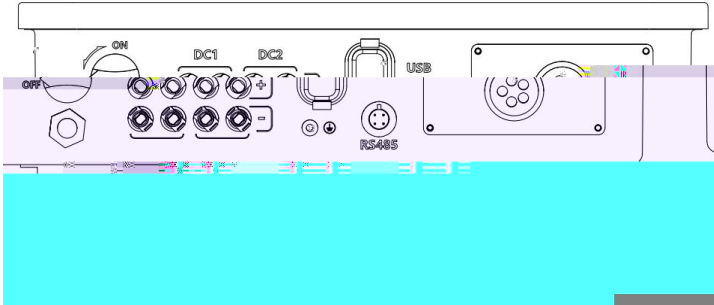

3.16



4

4.1

DC AC
DC AC
AC

4.2

- 1.
- 2.
- 3.

- 1.
2. 30 LED 30

5
b b b b

3.1

APP

l

h

5.3



5.3

" " " " " "

" "

" "



5. 4

5. 2

http://solar.ke-energycloud.com/8301/energycloud_solar/#/

5. 5

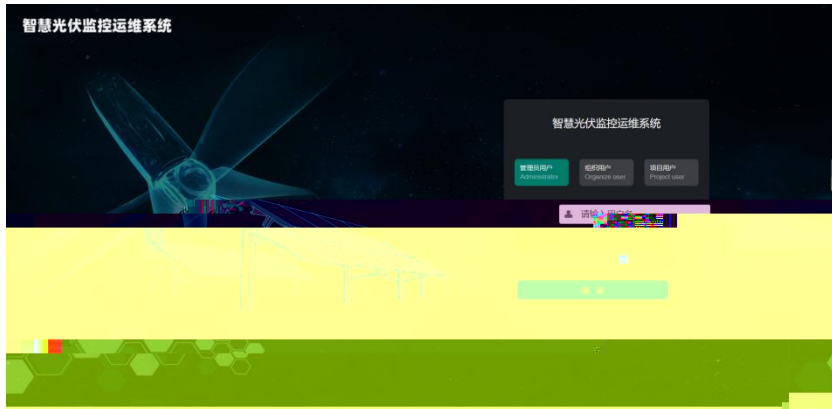

5.5

5.6



5.6

6

6.1

1

2

	4
	1 2 3
	1 2
	1 2
	1 2
	1 2 3
	1 2
	1 2
	1 2
	1 2
	1 2

6.1

8

:

: 0086-311-85231078 400-0311-128

: 0086-311-85231087

: <http://www.solarke.com/>